

ORTHOPHOS XG 3 DS

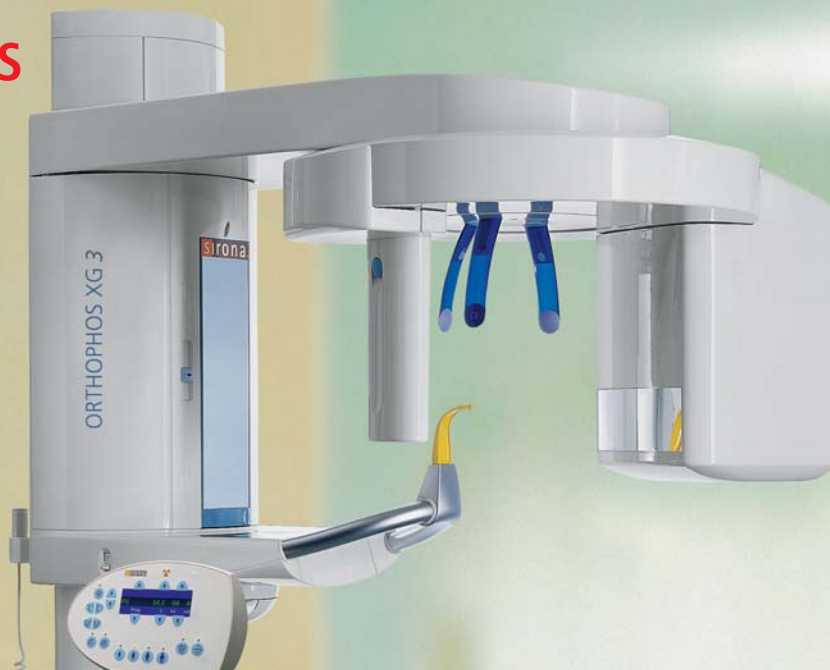

X-ray systems

**ORTHOPHOS XG 3 –
Digital panoramic X-ray
for practical diagnostics.**

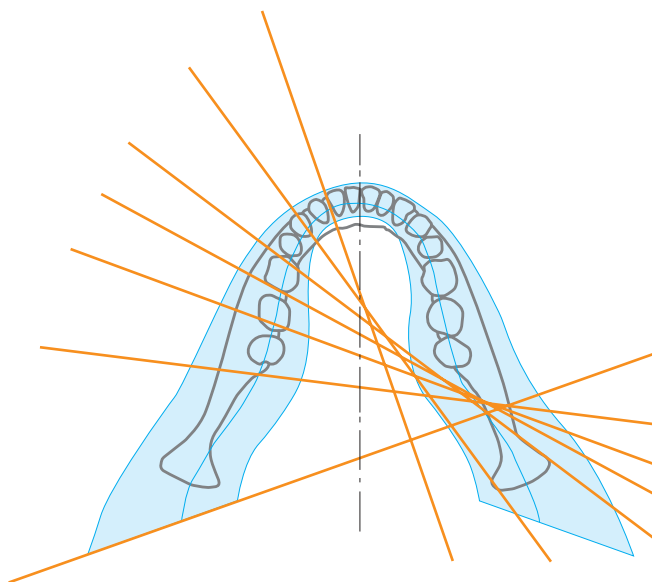

ORTHOPHOS XG 3 – Standard panoramic X-ray with proven technology.



competent
successful

Many years of competence as a technological leader!

For over a century now, Sirona (formerly Siemens Dental Systems) has been making history in the field of dental X-ray. Sirona was one of the co-inventors of panoramic X-ray and pioneered digital panoramic and cephalometric X-ray. This unique know-how and the first-class experience gained from the manufacture of over 40,000 panoramic X-ray systems are consistently applied to the development of new and innovative products. One excellent example of this is the ORTHOPHOS XG imaging family introduced in 2004, which sets benchmark standards of image quality and simple operation.

The ORTHOPHOS XG 3 – the new foundation for digital imaging!

The "XG system family" is now being extended to include a new model, the ORTHOPHOS XG 3. It is designed for the general practice dentist who would like to work with a basic X-ray system.

The XG 3 offers you an outstanding price-performance ratio and provides the following benefits:

- High image quality
- Extremely simple operation
- Solid workmanship

ORTHOPHOS XG 3 – Technology and design in harmony.



- 1 Effective 3-point patient stabilization
- 2 XG panoramic sensor (CCD)
- 3 Centrally controlled, motorized height adjustment, forehead and temple supports
- 4 Simple operation with the "Multipad"
- 5 Direct network capability

ORTHOPHOS XG 3

ORTHOPHOS XG 3 – A valuable approach for good image quality.



simple
logical

Sure positioning!

The ORTHOPHOS XG 3 uses the proven, logical Sirona principles for good image definition:

- Exact, immediate positioning of the anterior teeth in the focal layer.
- Effective, comfortable patient stabilization with forehead and temple supports to prevent motion blurring.
- Patients face themselves in the mirror for easy entry and fewer distractions.

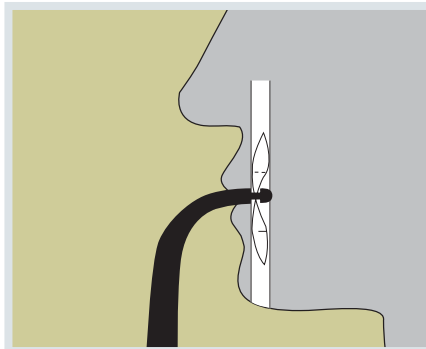

Proven technology!

The advanced technology from the XG product family enables the ORTHOPHOS XG 3 to produce high quality diagnostic images. The benefits include:

- Specific focal layers and orbital paths for anatomically optimized exposures.
- Very detailed display of the anterior tooth region through automatic kV adaptation as X-ray beam passes through spinal region.
- 16 bit Image acquisition technology provides more gray scales.
- SIDEXIS XG imaging software with useful analysis tools.



ORTHOPHOS XG 3 – Simple operation for higher efficiency.

fast
practical



Simple operation!

ORTHOPHOS XG 3 continues the Sirona tradition: Easy operation pays off through consistent, reliable results and time savings.

- Patient positioning using only two light localizers.
- Motorized adjustment of unit height, forehead and temple supports.
- Logical arrangement of centralized controls on the "Multipad" with flexible positioning.
- Exposure parameters selectable via intuitive patient symbol buttons.

Exact reproducibility!

The positioning and exposure parameters are automatically saved with the image data. This enables you to easily obtain truly comparable exposures for follow up diagnoses.

Informative digital diagnosis!

With SIDEXIS XG Imaging software, you will be able to make an accurate diagnosis quickly and easily. The flexible analytical functions add to your diagnostic capabilities. The patient files can be accessed, enhanced and used for treatment explanation and planning from any computer on the office network.

One convenient approach is to use the integrated chair-side monitor on the Sirona treatment center for patient education.

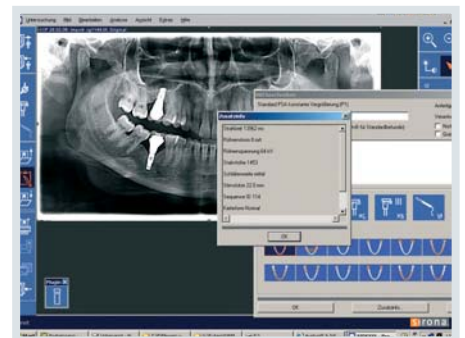

Automatically saved positioning and exposure parameters.



ORTHOPHOS XG 3 – Specific programs for a clear diagnosis.

P1

Standard panoramic view with orthoradial beam direction. For basic diagnosis.

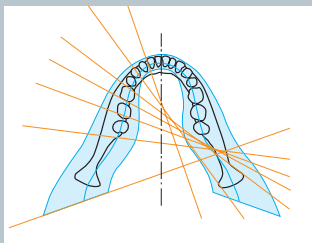

P1L / P1R

Left or right half of P1, e.g. for follow-up exam diagnoses.

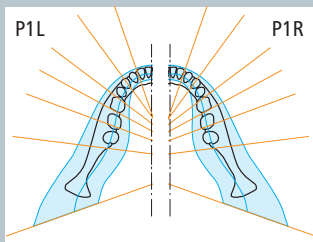

P1C

Panoramic view with constant magnification. Specific focal path for 1.25 to 1 magnification factor. For length measurements using a reference object.

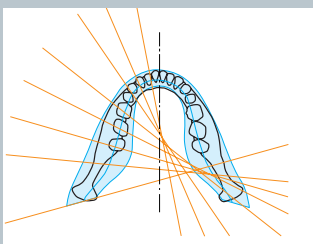

TM1

Lateral views of temporomandibular joint in closed/open position. Specific focal path and optimal projection angle for functional diagnosis of temporomandibular joints.

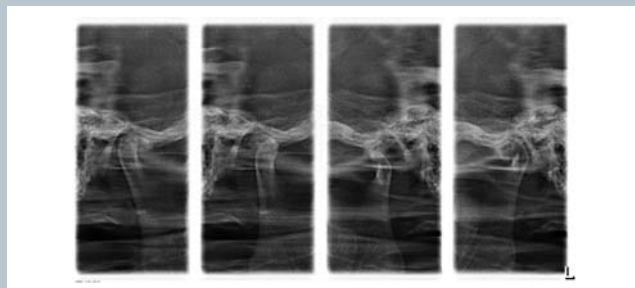
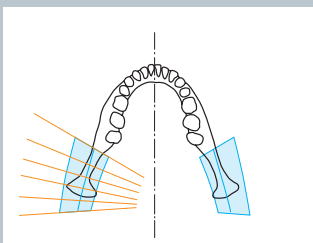

ORTHOPHOS XG 3 – Technical data.

Technical data	ORTHOPHOS XG 3 DS
Radiation generator	Multipulse generator (max. 120 kHz)
X-ray tube	SR 90/15 FN
Focal spot size compliant to IEC 336/82	0.5 mm x 0.5 mm
Total filter	2.5 mm AL
Tube voltage	60–90 kV
Tube current	3–16 mA
Nominal voltage	230–240 V, 50–60 Hz
Nominal current	12 A
Line internal resistance	max. 0.8 ohms
Fuse	16 A slow-blow
Power consumption	2.8 kW
Permissible line voltage fluctuations	± 10 %
Panoramic exposure time (P1)	14.2 s
Bite block height range	2'8" to 6' (800–1810 mm)

Technical features

- Centralized control via "Multipad"
- Optional remote control
- 90 kV high-frequency generator
- Spinal column compensation via automatic kV increase
- CCD sensor technology with high-speed interface, 27 µm pixel size and image acquisition with 16-bit technology, 100 Mbit Ethernet data transmission
- State-of-the-art data technology via integrated power PC and CAN bus architecture
- SIDEXIS XG image processing software
- Optional floor stand
- Suitable for patients in wheelchairs

Programs

- Standard orthoradial full dentition (P1)
- Standard orthoradial left (P1L)
- Standard orthoradial right (P1R)
- Panoramic view with constant 1.25x magnification (P1C)
- Lateral TMJ program with open and closed occlusion (TM1)



Remote control with display of exposure parameters.



Floor stand which can be screwed to the floor and can accommodate patients in wheelchairs.

Min. space requirement for ORTHOPHOS XG 3 DS: 50.4" x 55.6" (1280 x 1411 mm)

Front view

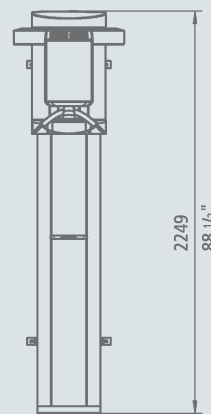

Top view

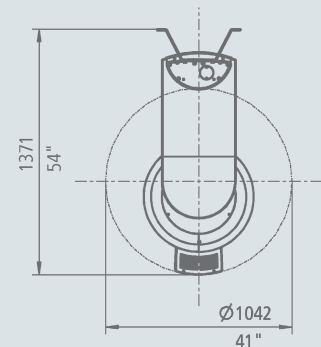

Height with floor stand: 89.75" (2,279 mm)

For additional direct digital diagnostic imaging capabilities,
ask your dental dealer about the rest of the Sirona ORTHOPHOS XG product family.



ORTHOPHOS XG 5

8 panoramic programs for dentists who require a variety of diagnostic capabilities or need a direct digital unit with full cephalometric capabilities.



ORTHOPHOS XG^{Plus}

Extended functionalities and virtually unlimited diagnostic capabilities for specialized dentists, implantologists and larger, expanded treatment dental clinics. Also available with a full featured direct digital cephalometric attachment and/or Transversal Slice Acquisition (TSA) options.

Sirona – creating and maintaining value.

Treatment centers
Handpieces
Hygiene systems
X-ray systems
CEREC

Logical. You are right to expect a great deal from the world's only full-range supplier of dental equipment – in particular, an extensive product portfolio, first class service, outstanding quality and tremendous value for money. Sirona covers the entire dental equipment spectrum: treatment centres, handpieces, X-ray systems, hygiene systems, imaging systems and – last but not least – CEREC ceramic restoration systems. Building products that stand the test of time, Sirona is the professional partner for the dental profession.

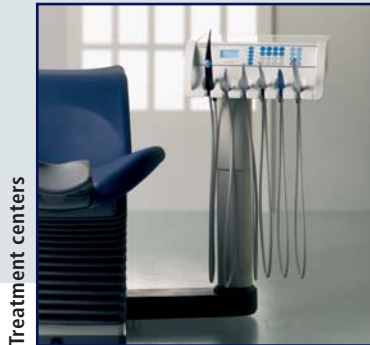

Treatment centers



Patient communication



X-ray systems

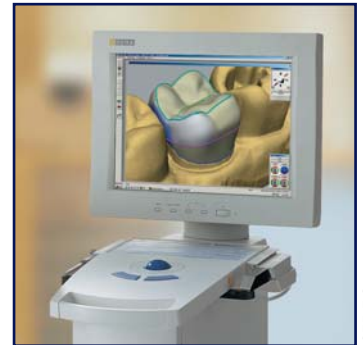

CEREC



Handpieces



Hygiene systems

Dealer's stamp

Sirona Dental Systems GmbH
Fabrikstrasse 31 · D-64625 Bensheim
E-mail: contact@sirona.de
www.sirona.com

Subject to technical changes and errors in the text, Order No. A91100-IM47-A854-01-7600, Printed in Germany, Dispo No. 04602, 2013C9896 WS 01075.